

CALE DE RULARE / TUBULAR TRACKS

| COD/ART N° | GREUTATE MAXIMA MAX. WEIGHT | D | H | S | kg /m | LUNGIME LENGTH |  |
|------------|-----------------------------------|----|----|-----|----------|-------------------|---|
| 100.100 | 100 kg | 30 | 28 | 2 | 1.365 | 6m | 20 |
| 100.300 | 300 kg | 39 | 34 | 2.5 | 2.140 | 6m | 20 |
| 100.400 | 400 kg | 49 | 44 | 3 | 3.400 | 6m | 10 |
| 100.500 | 500 kg | 65 | 60 | 4 | 6.250 | 6m | |

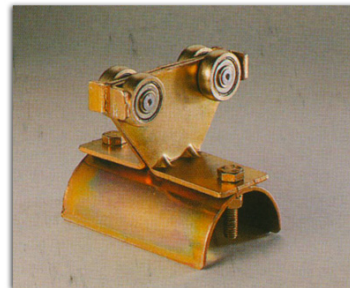
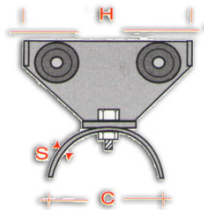
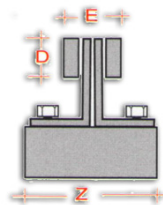

PURTATOR MOBIL CABLU / INTERMEDIATE CABLE HANGER

| COD/ART N° | L | H | S | C | D | E | Z | kg |
|------------|----|----|---|----|----|----|----|-------|
| 100.112 | 70 | 78 | 2 | 52 | 22 | 23 | 80 | 0.315 |

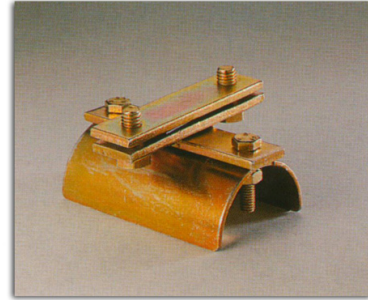
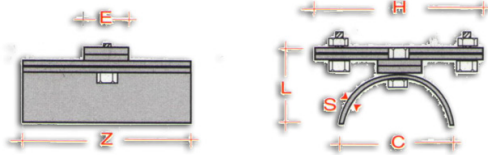

SISTEM FIX PRINDERE CALBU / END CABLE HANGER

| COD/ART N° | L | H | S | C | E | Z | kg |
|------------|----|----|---|----|----|----|-------|
| 100.113 | 41 | 86 | 2 | 52 | 20 | 80 | 0.290 |

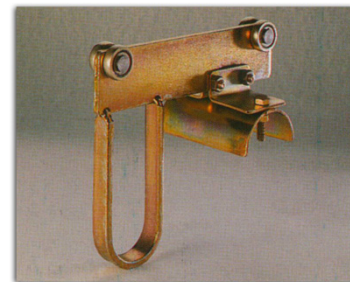
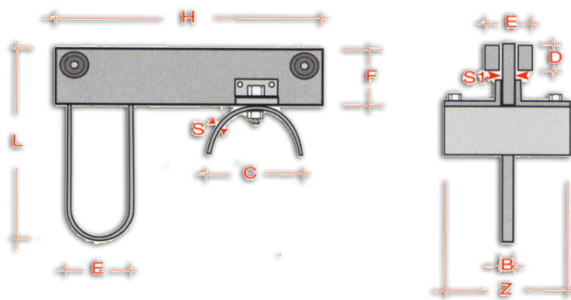

RAULA PRIMARA PURTATOARE CABLU

| COD/ART N° | H | L | K | C | F | E | B | Z | S1 | S2 | kg |
|------------|-----|-----|----|----|----|----|----|----|----|----|-------|
| 100.114 | 164 | 145 | 50 | 52 | 40 | 23 | 12 | 80 | 5 | 2 | 0.605 |